



The Hand Book

Sliding & Folding



Technik für Möbel

Hettich

Categorisation of Sliding Folding Systems :

Hettich Sliding Folding Systems can be categorised as per following :

- TopLine : Sliding Systems in which weight of the Door is supported by the Top Runner Profile
- SlideLine : Sliding System in which weight of the door is supported by the Bottom Runner Profile
- WingLine : Folding door systems when the door in Carcass folds in a fixed or a moving axis
- RoomLine : Sliding & Folding Systems that is used in room partitions

Best Carcass Construction techniques for superior Sliding/Folding Performance:

- Top Horizontal Panel of Wardrobe should be strong , straight and parallel to Bottom Horizontal Panel
- Required Vertical Plumb Divider panels to prevent the Top panel from sagging
- Height and Width ratio of the Door should not be less than 2:1 (eg; If height is 2000mm, width must be 1000 mm)
- Wardrobe Carcass with Sliding/Folding Doors should be installed on levelled floor measured by Spirit level.
- All Corners of Carcass should be at 90° to each other

Definition of Important dimensions related to Sliding/Folding Doors :

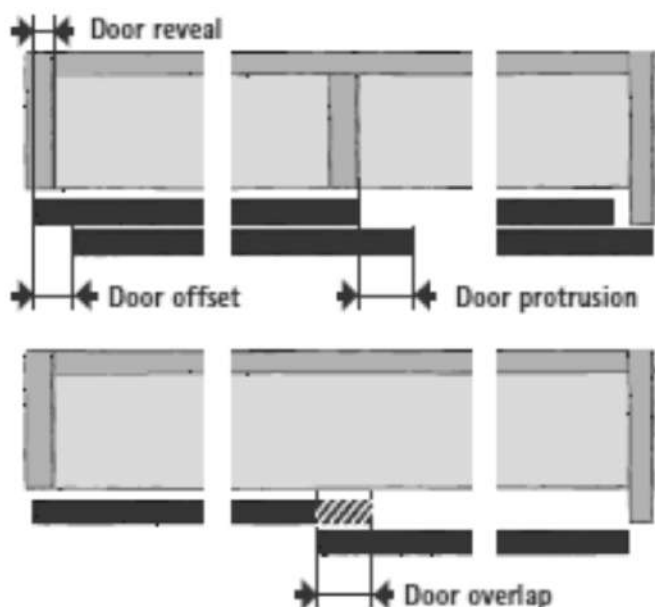

Door Reveal :: Door level is the measurement which the door overlaps the carcass side panel

Door Protrusion : Door protrusion is the measurement of the door offset from the vertical centre panel of the carcass

Door Offset : Door offset is the distance the front door is prevented from travelling so that it does not hit the rear Door handle

Door Overlap : Door Overlap is the measurement by which the Front Most door covers the Rear most Door of the carcass. The overlap should be at least twice or more the gap distance between Front Door and Rear Door for visual obstruction

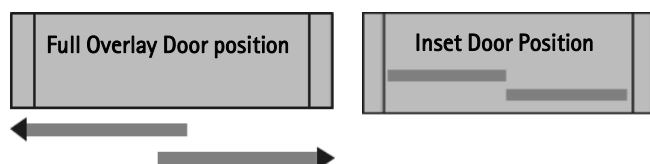

Full Overlay Doors : Overlay Doors are positioned in front of the carcass leaving all the space inside the carcass available for use

Inset Doors: Inset Doors are set inside the carcass. Inside panels and shelves need to be shorter than internal depth to accommodate the inset leaving lesser space for storage

Sliding & Folding Systems

Appendix

What does Sliding/Folding Fittings generally consists of :

Every Sliding/Folding System will have the following components ::

- Runner Profile (Position in Top Panel/Ceiling)
- Guide Profile (Position in Bottom panel/Floor)
- Installation Kit (Creates connection between the door and the Runner/Guide Profile)
- End Stops (To Stop the Door at a predetermined point) (Optional)
- Slient Systems (Soft Opening, Soft Closing, Soft Colliding). are Door movement controls (Optional)

Quality Criteria:

All Hettich Sliding/Folding Systems pass the Overload test of European standard EN 15706 which consists of

- **Endurance Test** (Opening & Closing Test :10000 to 40000 cycles)

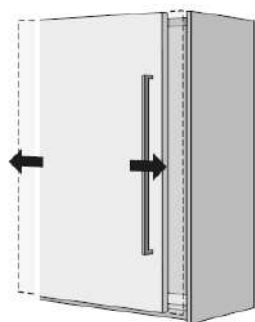

Level 1: 10,000 cycles
Level 2: 20,000 cycles
Level 3: 40,000 cycles

- **Lift Off Guard Test** (Force of Pulling up Test 150N to 250N)



Level 1: 150 N
Level 2: 200 N
Level 3: 250 N

- **Closing Test** (Closing cycles endurance test with extra tensile load of 2-4 kg)

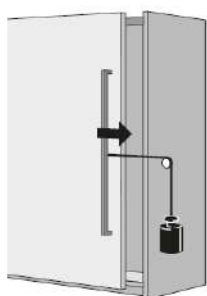

Level 1: 2 kg
Level 2: 3 kg
Level 3: 4 kg

- **Horizontal Safety Test** (Resistance against door falling off against extra pressure of 150-250 N)

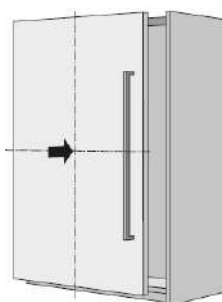

Level 1: 150 N
Level 2: 200 N
Level 3: 250 N

All Hettich Sliding/Folding pass the Corrosion Resistance test as per EN 6270 (72 hour Condensation Water Test

*Please refer to Quality Criteria of each product in individual pages

The Hand Book

Sliding & Folding

TopLine

Top running Doors

SlideLine

Bottom running Doors

WingLine

Folding Doors

RoomLine

Room Partition



Technik für Möbel

Hettich

Flush fitted, Sliding door system: InLine XL



Salient Features

| | |
|------------------------------|--|
| Maximum Cabinet Width | 4000 mm (3600 mm for India) |
| Description | Flush fitted Sliding door system for large cabinets with 2 doors |
| Number of Tracks | 1 Top Et 1 Bottom Track |
| Door Action | Horizontal |
| Door Position | Overlay |
| Door Weight | 60 Kg per door (Max.) |
| Door Height | 2600 mm |
| Door Width | 2000 mm (1800 mm for India) |
| Door Thickness | 16 – 25 mm |
| Door Combinations | 2 Door Sliding |
| Silent Systems | Soft Opening Et Soft Closing |
| Special Features | Adjustment of Height, Door overlay Et Tilt |

Quality Criteria

- Endurance test over 40,000 cycles (EN 15706 Level 3)
- Closing test with a pulling force of 4 kg (EN 15706 Level 3)
- Lift out test at 250 N (EN 15706 Level 3)
- Load test in Horizontal direction at 250N(EN 15706 Level 3)
- Corrosion Test : 72 Hours Condensation Test (EN 6270)**

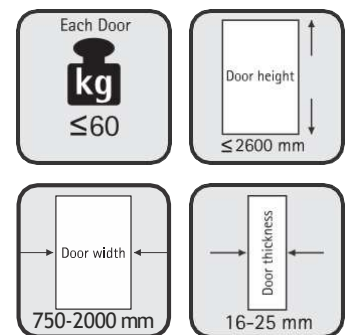

| Article No. | Description | Qty | Unit | PU | MRP |
|-------------|--|-----|------|----|----------|
| 9148180 | Door width 750 -819 mm (max.door height 2000 mm) | 1 | Set | 1 | 1,09,846 |
| 9148201 | Door width 820 -909 mm (max.door height 2000 mm) | 1 | Set | 1 | 1,09,833 |
| 9148202 | Door width 910 -1044 mm (max.door height 2200 mm) | 1 | Set | 1 | 1,09,887 |
| 9148203 | Door width 1045 -1199 mm (max.door height 2200 mm) | 1 | Set | 1 | 1,00,971 |
| 9148204 | Door width 1200 -1299 mm (max.door height 2400 mm) | 1 | Set | 1 | 1,04,127 |
| 9148205 | Door width 1300 -1499 mm (max.door height 2400 mm) | 1 | Set | 1 | 1,07,283 |
| 9148206 | Door width 1500 -1599 mm (max.door height 2600 mm) | 1 | Set | 1 | 1,10,439 |
| 9116581 | Door width 1600 -1799 mm (max.door height 2600 mm) | 1 | Set | 1 | 1,13,595 |

Whisper quiet. Soft opening, Soft closing & Synchronised Opening doors for large format Wardrobe: **TopLine XL K2**



| Article No. | Description | Qty | Unit | PU | MRP |
|---|---|-----|------|----|-----|
| TopLine XL K2 2 Doors (Door Thickness 18-30 mm) | | | | | |
| 9 275 788 | Runner & Guide Components for 2 Doors (60-100 kg) | 1 | Set | 1 | |
| 9 278 657 | Runner & Guide Profile 4000 mm with Clip set complete | 1 | Set | 1 | |
| 9 276 737 | Silent System for 2 Doors (60-100 kg) | 1 | Set | 1 | |
| TopLine XI K2 (18-30 mm) 2 Doors Set | | | | | |
| TopLine XL K2 3 Doors (Door Thickness 18-30 mm) | | | | | |
| 9 275 781 | Runner & Guide Components for 3 Doors (60-100 kg) | 1 | Set | 1 | |
| 9 278 657 | Runner & Guide Profile 4000 mm with Clip set complete | 1 | Set | 1 | |
| 9 276 646 | Silent System for 3 Doors (60-100 kg) | 1 | Set | 1 | |
| TopLine XI K2 (18-30 mm) 3 Doors Set | | | | | |
| TopLine XL K2 4 Doors (Door Thickness 18-30 mm) | | | | | |
| 9 275 794 | Runner & Guide Components for 4 Doors (30-80 kg) | 1 | Set | 1 | |
| 9 278 657 | Runner & Guide Profile 4000 mm with Clip set complete | 1 | Set | 1 | |
| 9 278 799 | Silent System for 4 Doors (30-80 kg) | 1 | Set | 1 | |
| TopLine XI K2 (18-30 mm) 4 Doors Set | | | | | |
| TopLine XL K2 2 Doors (Door Thickness 32-40 mm) | | | | | |
| 9 275 708 | Runner & Guide Components for 2 Doors (60-100 kg) | 1 | Set | 1 | |
| 9 278 657 | Runner & Guide Profile 4000 mm with Clip set complete | 1 | Set | 1 | |
| 9 276 737 | Silent System for 2 Doors (60-100 kg) | 1 | Set | 1 | |
| TopLine XI K2 (32-40 mm) 2 Doors Set | | | | | |
| TopLine XL K2 3 Doors (Door Thickness 32-40 mm) | | | | | |
| 9 275 707 | Runner & Guide Components for 3 Doors (60-100 kg) | 1 | Set | 1 | |
| 9 278 657 | Runner & Guide Profile 4000 mm with Clip set complete | 1 | Set | 1 | |
| 9 276 646 | Silent System for 3 Doors (60-100 kg) | 1 | Set | 1 | |
| TopLine XI K2 (32-40 mm) 3 Doors Set | | | | | |
| TopLine XL K2 4 Doors (Door Thickness 32-40 mm) | | | | | |
| 9 275 797 | Runner & Guide Components for 4 Doors (30-80 kg) | 1 | Set | 1 | |
| 9 278 657 | Runner & Guide Profile 4000 mm with Clip set complete | 1 | Set | 1 | |
| 9 278 799 | Silent System for 4 Doors (30-80 kg) | 1 | Set | 1 | |
| TopLine XI K2 (32-40 mm) 4 Doors Set | | | | | |
| Accessories | | | | | |
| 9 278 801 | Cover Profile 2000 mm | 1 | Set | 1 | |
| 9 209 403 | Self Adhesive Decorative Tape 4000 mm (Black) | 1 | Set | 1 | |
| 9 209 405 | Self Adhesive Decorative Tape 4000 mm (White) | 1 | Set | 1 | |
| 9 209 407 | Self Adhesive Decorative Tape 4000 mm (Champagne) | 1 | Set | 1 | |

Prices will be updated later when the product gets added in our inventory

Salient Features

| | |
|-----------------------|---|
| Maximum Cabinet Width | 4000 mm |
| Description | Sliding door system with SiSy for large cabinets with 2/3/4 doors |
| Number of Tracks | 1 Top & 1 Bottom Track |
| Door Action | Horizontal |
| Door Position | Overlay |
| Door Weight | 30-80-100 kg per Door |
| Door Height | 3000 mm Max. |
| Door Width | 2000 mm Max. |
| Door Thickness | 16 - 40 mm |
| Door Combinations | 2/3/4 (Synchronised) Door Sliding |
| Silent Systems | Soft Opening & Soft Closing |
| Special Features | Adjustment of Height & Door overlay |

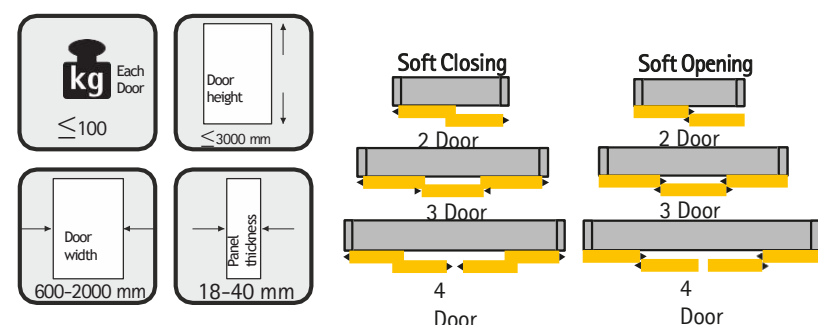

Quality Criteria

- Endurance test over 40,000 cycles (EN 15706 Level 3)
- Closing test with a pulling force of 4 kg (EN 15706 Level 3)
- Lift out test at 250 N (EN 15706 Level 3)
- Load test in Horizontal direction at 250N(EN 15706 Level 3)
- Corrosion Test : 72 Hours Condensation Test (EN 6270)**

TopLine XL

Top Running Doors

4000

Whisper quiet. Soft opening, Soft closing & Synchronised Opening doors for large format Wardrobe: TopLine XL



Salient Features

| | |
|-----------------------|---|
| Maximum Cabinet Width | 4000 mm |
| Description | Sliding door system with SiSy for large cabinets with 2/3/4 doors |
| Number of Tracks | 1 Top & 1 Bottom Track |
| Door Action | Horizontal |
| Door Position | Overlay |
| Door Weight | 30-80 kg per Door |
| Door Height | 2600 mm Max. |
| Door Width | 1500 -2000 mm Max. |
| Door Thickness | 16 - 40 mm |
| Door Combinations | 2/3/4 (Synchronised) Door Sliding |
| Silent Systems | Soft Opening & Soft Closing |
| Special Features | Adjustment of Height & Door overlay |

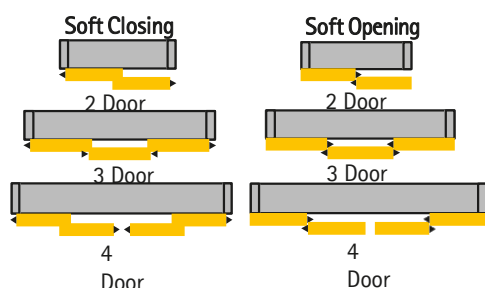
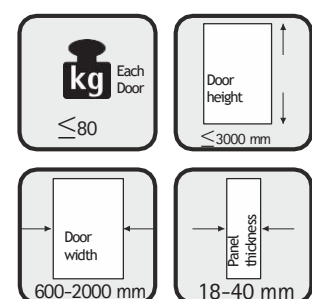

| Description | MRP |
|--|--------|
| TopLine XL 2 Doors (3000 mm Cabinet) | |
| TopLine XL Set 19 mm Thick Door (Frontmost Door Kit+ Rearmost Door Kit+ Soft Closing & Opening System + 3000 mm Runner, Guide & Cover Profile) | 48747 |
| TopLine XL Set 22 mm Thick Door (Frontmost Door Kit+ Rearmost Door Kit+ Soft Closing & Opening System + 3000 mm Runner, Guide & Cover Profile) | 48747 |
| TopLine XL Set 28 mm Thick Door (Frontmost Door Kit+ Rearmost Door Kit+ Soft Closing & Opening System + 3000 mm Runner, Guide & Cover Profile) | 48747 |
| TopLine XL Set 40 mm Thick Door (Frontmost Door Kit+ Rearmost Door Kit+ Soft Closing & Opening System + 3000 mm Runner, Guide & Cover Profile) | 55727 |
| TopLine XL 2 Doors (4000 mm Cabinet) | |
| TopLine XL Set 19 mm Thick Door (Frontmost Door Kit+ Rearmost Door Kit+ Soft Closing & Opening System + 4000 mm Runner, Guide & Cover Profile) | 53626 |
| TopLine XL Set 22 mm Thick Door (Frontmost Door Kit+ Rearmost Door Kit+ Soft Closing & Opening System + 4000 mm Runner, Guide & Cover Profile) | 53626 |
| TopLine XL Set 28 mm Thick Door (Frontmost Door Kit+ Rearmost Door Kit+ Soft Closing & Opening System + 4000 mm Runner, Guide & Cover Profile) | 53626 |
| TopLine XL Set 40 mm Thick Door (Frontmost Door Kit+ Rearmost Door Kit+ Soft Closing & Opening System + 4000 mm Runner, Guide & Cover Profile) | 60606 |
| TopLine XL 3 Doors (4000 mm Cabinet) | |
| TopLine XL Set 19 mm Thick Door (Frontmost Door Kit+ 2 Rearmost Door Kit+ Soft Closing & Opening System + 4000 mm Runner, Guide & Cover Profile) | 69412 |
| TopLine XL Set 22 mm Thick Door (Frontmost Door Kit+ 2 Rearmost Door Kit+ Soft Closing & Opening System + 4000 mm Runner, Guide & Cover Profile) | 69412 |
| TopLine XL Set 28 mm Thick Door (Frontmost Door Kit+ 2 Rearmost Door Kit+ Soft Closing & Opening System + 4000 mm Runner, Guide & Cover Profile) | 69412 |
| TopLine XL Set 40 mm Thick Door (Frontmost Door Kit+ 2 Rearmost Door Kit+ Soft Closing & Opening System + 4000 mm Runner, Guide & Cover Profile) | 76752 |
| TopLine XL 4 Door Synchronised (3000 mm Cabinet) | |
| TopLine XL Set 19 mm Thick Door (2 Frontmost Door Kit+ 2 Rearmost Door Kit+ Soft Closing & Opening System + 3000 mm Runner, Guide & Cover Profile) | 112783 |
| TopLine XL Set 22 mm Thick Door (2 Frontmost Door Kit+ 2 Rearmost Door Kit+ Soft Closing & Opening System + 3000 mm Runner, Guide & Cover Profile) | 112783 |
| TopLine XL Set 28 mm Thick Door (2 Frontmost Door Kit+ 2 Rearmost Door Kit+ Soft Closing & Opening System + 3000 mm Runner, Guide & Cover Profile) | 112783 |
| TopLine XL Set 40 mm Thick Door (2 Frontmost Door Kit+ 2 Rearmost Door Kit+ Soft Closing & Opening System + 3000 mm Runner, Guide & Cover Profile) | 122506 |
| TopLine XL 4 Door Synchronised (4000 mm Cabinet) | |
| TopLine XL Set 19 mm Thick Door (2 Frontmost Door Kit+ 2 Rearmost Door Kit+ Soft Closing & Opening System + 4000 mm Runner, Guide & Cover Profile) | 122963 |
| TopLine XL Set 22 mm Thick Door (2 Frontmost Door Kit+ 2 Rearmost Door Kit+ Soft Closing & Opening System + 4000 mm Runner, Guide & Cover Profile) | 122963 |
| TopLine XL Set 28 mm Thick Door (2 Frontmost Door Kit+ 2 Rearmost Door Kit+ Soft Closing & Opening System + 4000 mm Runner, Guide & Cover Profile) | 122963 |
| TopLine XL Set 40 mm Thick Door (2 Frontmost Door Kit+ 2 Rearmost Door Kit+ Soft Closing & Opening System + 4000 mm Runner, Guide & Cover Profile) | 132686 |
| Accessories | |
| 2000 mm Cover Profile Frontmost Door | 1424 |

Quality Criteria

- Endurance test over 40,000 cycles (EN 15706 Level 3)
- Closing test with a pulling force of 4 kg (EN 15706 Level 3)
- Lift out test at 250 N (EN 15706 Level 3)
- Load test in Horizontal direction at 250N(EN 15706 Level 3)
- Corrosion Test : 72 Hours Condensation Test (EN 6270)**

Move to next level of comfort : Soft closing & opening Sliding door system:

Topline L



| Salient Features | |
|-----------------------|---|
| Maximum Cabinet Width | 3000 mm |
| Description | Sliding door system with SiSy for large cabinets with 2/3 doors |
| Number of Tracks | 1 Top Et 1 Bottom Track |
| Door Action | Horizontal |
| Door Position | Overlay |
| Door Weight | 50 kg per Door Max |
| Door Height | 2600 mm Max. |
| Door Width | 550-1500 mm (2 Door)/1350 mm (3 Door) |
| Door Thickness | 18 - 30 mm |
| Door Combinations | 2/3 Door Sliding |
| Silent Systems | Soft Opening, Soft Closing Et Soft Colliding |
| Special Features | Adjustment of Height Et Door overlay |

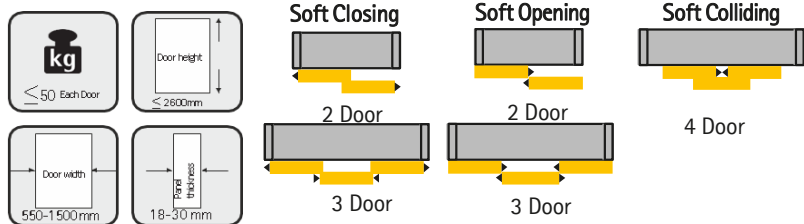

| Article No. | Description | Qty | Unit | PU | MRP |
|---|---|-----|------|----|--------------|
| TopLine For Door Thickness 19 mm | | | | | |
| 9 206 500 | Front most door set - 19 mm | 1 | Set | 1 | 5654 |
| 9 206 505 | Rear most door set for offset opening | 1 | Set | 1 | 3614 |
| 9 206 309 | Accessory set for offset opening | 1 | Set | 1 | 516 |
| 9 169 651 | Silent System soft closing set for offset opening | 1 | Set | 1 | 4860 |
| 9 169 637 | Silent System soft opening set for offset opening | 1 | Set | 1 | 3962 |
| 0 071 111 | Runner profile for installing in front of top panel | 1 | Pc | 4 | 1678 |
| 0 071 117 | STB 11 guide profile | 1 | Pc | 4 | 1595 |
| TopLine L 2 Door (19 mm) | | | | | 21879 |
| TopLine For Door Thickness 22 mm | | | | | |
| 9 206 501 | Front most door set - 22 mm | 1 | Set | 1 | 4605 |
| 9 206 505 | Rear most door set for offset opening | 1 | Set | 1 | 3614 |
| 9 206 309 | Accessory set for offset opening | 1 | Set | 1 | 516 |
| 9 169 651 | Silent System soft closing set for offset opening | 1 | Set | 1 | 4860 |
| 9 169 637 | Silent System soft opening set for offset opening | 1 | Set | 1 | 3962 |
| 0 071 111 | Runner profile for installing in front of top panel | 1 | Pc | 4 | 1678 |
| 0 071 117 | STB 11 guide profile | 1 | Pc | 4 | 1595 |
| TopLine L 2 Door (22 mm) | | | | | 20830 |
| TopLine For Door Thickness 25 mm | | | | | |
| 9 206 502 | Front most door set - 25 mm | 1 | Set | 1 | 5770 |
| 9 206 505 | Rear most door set for offset opening | 1 | Set | 1 | 3614 |
| 9 206 309 | Accessory set for offset opening | 1 | Set | 1 | 516 |
| 9 169 651 | Silent System soft closing set for offset opening | 1 | Set | 1 | 4860 |
| 9 169 637 | Silent System soft opening set for offset opening | 1 | Set | 1 | 3962 |
| 0 071 111 | Runner profile for installing in front of top panel | 1 | Pc | 4 | 1678 |
| 0 071 117 | STB 11 guide profile | 1 | Pc | 4 | 1595 |
| TopLine L 2 Door (25 mm) | | | | | 21995 |
| TopLine For Door Thickness 40 mm | | | | | |
| 9 206 503 | Front most door set - 40 mm | 1 | Set | 1 | 8858 |
| 9 206 505 | Rear most door set for offset opening | 1 | Set | 1 | 3614 |
| 9 206 309 | Accessory set for offset opening | 1 | Set | 1 | 516 |
| 9 169 651 | Silent System soft closing set for offset opening | 1 | Set | 1 | 4860 |
| 9 169 637 | Silent System soft opening set for offset opening | 1 | Set | 1 | 3962 |
| 0 071 111 | Runner profile for installing in front of top panel | 1 | Pc | 4 | 1678 |
| 0 071 117 | STB 11 guide profile | 1 | Pc | 4 | 1595 |
| TopLine L 2 Door (40 mm) | | | | | 25083 |

Prices will be updated later as per new additions

Quality Criteria

Endurance test over 40,000 cycles (EN 15706 Level 3)

Closing test with a pulling force of 4 kg (EN 15706 Level 3)

Lift out test at 250 N (EN 15706 Level 3)

Load test in Horizontal direction at 250N(EN 15706 Level 3)

Corrosion Test : 72 Hours Condensation Test (EN 6270)

Versatile & Most preferred Sliding system. Suitable for Wooden & Aluminium framed doors : TopLine 22 Advanced

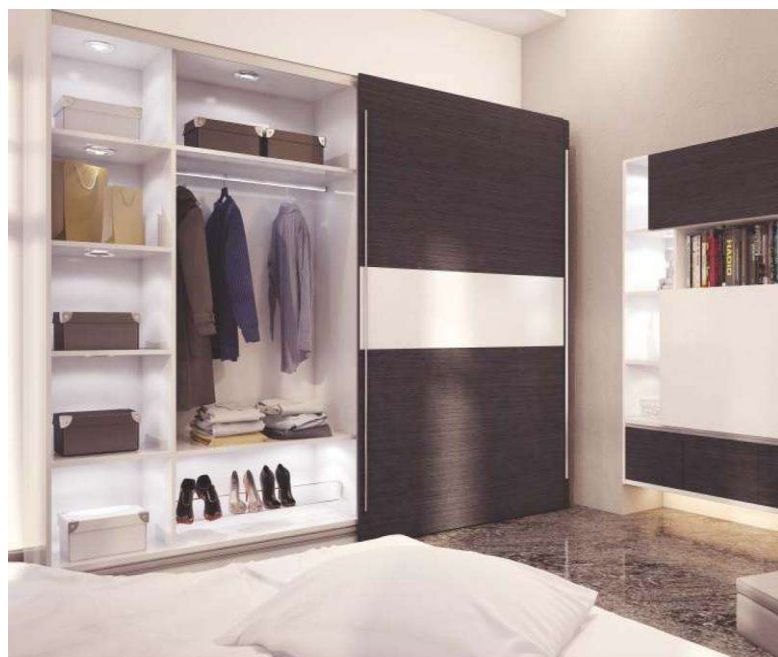

Salient Features

| | |
|------------------------------|---|
| Maximum Cabinet Width | 3000 mm |
| Description | Sliding door system with Soft Closing for large cabinets with 2/3 doors |
| Number of Tracks | 1 Top & 1 Bottom Track |
| Door Action | Horizontal |
| Door Position | Overlay |
| Door Weight | 50 kg per Door Max |
| Door Height | 2500 mm Max. |
| Door Width | 500-1500 mm (2 Door) / 500-1000 (3 Door) |
| Door Thickness | 16-28 mm |
| Door Combinations | 2/3 Door Sliding |
| Silent Systems | Soft Closing |
| Special Features | Adjustment of Height |

| Carcass Width | Description | Qty | Unit | MRP |
|----------------|---|-----|------|-------|
| 2 Doors | | | | |
| 3000 mm | TopLine 22 Advanced (28 mm Thick Door) : 2 Door System with Runner Profile (3000 mm) and Guide Profile STB 11); Runner & Guide Installation Set, Silent System and Cover Profile (1000 mm) | 1 | Set | 17480 |
| 3000 mm | TopLine 22 Advanced (28 mm Thick Door) : 2 Door System with Runner Profile (3000 mm) and Guide Profile STB12; Runner & Guide Installation Set, Silent System and Cover Profile (1000 mm) | 1 | Set | 17716 |
| 3000 mm | TopLine 22 Advanced (28 mm Thick Door) : 2 Door System with Runner Profile (3000 mm) and Guide Profile STB 15 (; Runner & Guide Installation Set, Silent System and Cover Profile (1000 mm) | 1 | Set | 18282 |
| 3 Doors | | | | |
| 3000 mm | TopLine 22 Advanced (28 mm Thick Door) : 3 Door System with Runner Profile (3000 mm) and Guide Profile STB 11; Runner & Guide Installation Set, Silent System and Cover Profile (1000 mm) | 1 | Set | 19955 |
| 3000 mm | TopLine 22 Advanced (28 mm Thick Door) : 3 Door System with Runner Profile (3000 mm) and Guide Profile STB 12; Runner & Guide Installation Set, Silent System and Cover Profile (1000 mm) | 1 | Set | 20315 |

Soft Closing

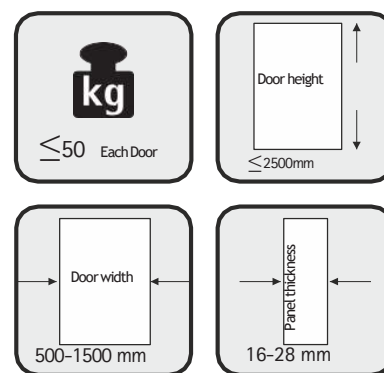
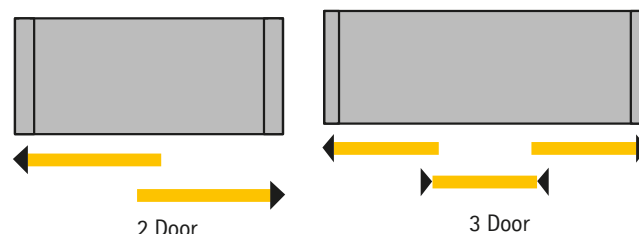

Quality Criteria

- Endurance test over 40,000 cycles (EN 15706 Level 3)
- Closing test with a pulling force of 4 kg (EN 15706 Level 3)
- Lift out test at 250 N (EN 15706 Level 3)
- Load test in Horizontal direction at 250 N(EN 15706 Level 3)
- Corrosion Test : 72 Hours Condensation Test (EN 6270)**

Time tested, most reliable Inset Sliding System for heavy wardrobe doors : TopLine 1



Salient Features

| | |
|-----------------------|--|
| Maximum Cabinet Width | 3000 mm |
| Description | Inset Sliding door system for large cabinets with 2/3 doors (50/75 kg) |
| Number of Tracks | 1 Top & 1 Bottom Track |
| Door Action | Horizontal |
| Door Position | Inset |
| Door Weight | 50 & 75 kg per Door Max |
| Door Height | 2500 mm Max. |
| Door Width | 500-1500 mm (2 Door) / 500-1000 (3 Door) |
| Door Thickness | 16-19 mm |
| Door Combinations | 2/3 Door Sliding |
| Silent Systems | No |
| Special Features | Adjustment of Height |

| Carcass Width | Description | Qty | Unit | MRP |
|-----------------------------|---|-----|------|-------|
| 2 Doors (50 Kg/Door) | | | | |
| 3000 mm | TopLine 1 (50 Kg): 2 Door System with Runner Profile and Guide Profile STB 11 (3000 mm) including Runner & Guide Installation Set, | 1 | Set | 8388 |
| 3000 mm | TopLine 1 (50 kg) : 2 Door System with Runner Profile and Guide Profile STB 12 (3000 mm) including Runner & Guide Installation Set, | 1 | Set | 8624 |
| 3000 mm | TopLine 1 (50 kg) : 2 Door System with Runner Profile and Guide Profile STB 35 (3000 mm) including Runner & Guide Installation Set, | 1 | Set | 5634 |
| 2 Doors (75 Kg/Door) | | | | |
| 3000 mm | TopLine 1 (75 Kg): 2 Door System with Runner Profile and Guide Profile STB 11 (3000 mm) including Runner & Guide Installation Set, | 1 | Set | 10309 |
| 3000 mm | TopLine 1 (75 kg) : 2 Door System with Runner Profile and Guide Profile STB 12 (3000 mm) including Runner & Guide Installation Set, | 1 | Set | 10545 |
| 3000 mm | TopLine 1 (75 kg) : 2 Door System with Runner Profile and Guide Profile STB 35 (3000 mm) including Runner & Guide Installation Set, | 1 | Set | 7555 |
| 3 Doors (50 Kg/Door) | | | | |
| 3000 mm | TopLine 1 (50 Kg): 3 Door System with Runner Profile and Guide Profile STB 11 (3000 mm) including Runner & Guide Installation Set, | 1 | Set | 9576 |
| 3000 mm | TopLine 1 (50 kg) : 3 Door System with Runner Profile and Guide Profile STB 12 (3000 mm) including Runner & Guide Installation Set, | 1 | Set | 9936 |
| 3000 mm | TopLine 1 (50 kg) : 3 Door System with Runner Profile and Guide Profile STB 35 (3000 mm) including Runner & Guide Installation Set, | 1 | Set | 6536 |
| 3 Doors (75 Kg/Door) | | | | |
| 3000 mm | TopLine 1 (75 Kg): 3 Door System with Runner Profile and Guide Profile STB 11 (3000 mm) including Runner & Guide Installation Set, | 1 | Set | 12552 |
| 3000 mm | TopLine 1 (75 kg) : 3 Door System with Runner Profile and Guide Profile STB 12 (3000 mm) including Runner & Guide Installation Set, | 1 | Set | 12912 |
| 3000 mm | TopLine 1 (75 kg) : 3 Door System with Runner Profile and Guide Profile STB 35 (3000 mm) including Runner & Guide Installation Set, | 1 | Set | 9512 |

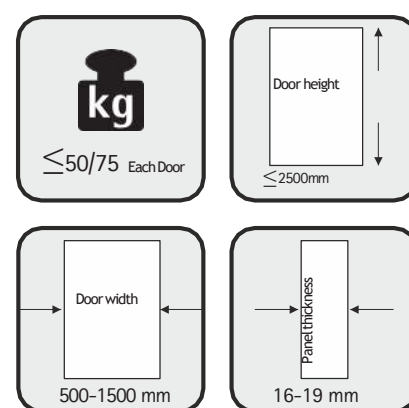
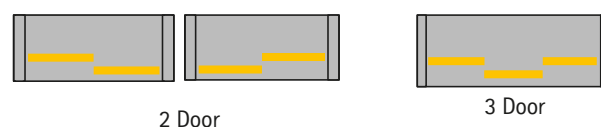

Quality Criteria

- Endurance test over 40,000 cycles (EN 15706 Level 3)
- Closing test with a pulling force of 4kg (EN 15706 Level 3)
- Lift out test at 250 N (EN 15706 Level 3)
- Load test in Horizontal direction at 250N(EN 15706 Level 3)
- Corrosion Test : 72 Hours Condensation Test (EN 6270)**

Designers delight yet cost effective : Sliding door system for wardrobes : Topline M



Salient Features

| | |
|-----------------------|--|
| Maximum Cabinet Width | 2000 mm |
| Description | Top Running Sliding door system for medium cabinets with 2 doors (35 kg) |
| Number of Tracks | 1 Top Et 1 Bottom Track |
| Door Action | Horizontal |
| Door Position | Overlay |
| Door Weight | 35 kg per Door |
| Door Height | 2300 mm Max. |
| Door Width | 650-1000 mm |
| Door Thickness | 16-19 mm |
| Door Combinations | 2 Door Sliding |
| Silent Systems | Yes |
| Special Features | Adjustment of Height |

| Article No. | Description | Qty | Unit | PU | MRP |
|-------------|--|-----|------|----|--------------|
| 9 117 425 | Top Runner Profile 2000 mm | 1 | Nos | 1 | 2326 |
| 9 117 429 | Bottom Guide Profile 2000 mm STB 16.2 (Below Bottom Panel) | 1 | Nos | 1 | 562 |
| 9 133 641 | 2 Door Guide Runner Set for Guide Profile STB 16.2 | 1 | Set | 1 | 4153 |
| 9 144 901 | Silent System 2 Door | 1 | Set | 1 | 3412 |
| 9 200 386 | Brush Sealing Strip 2500 mm (3 nos for 2 Door System) | 1 | Nos | 1 | 227 |
| | TopLine M Set | | | | 10680 |

Quality Criteria

Endurance test over 20,000 cycles (EN 15706 Level 2)

Closing test with a pulling force of 3 kg (EN 15706 Level 2)

Lift out test at 200 N (EN 15706 Level 2)

Load test in Horizontal direction at 200 N(EN 15706 Level 2)

Corrosion Test : 72 Hours Condensation Test (EN 6270)

Soft Closing

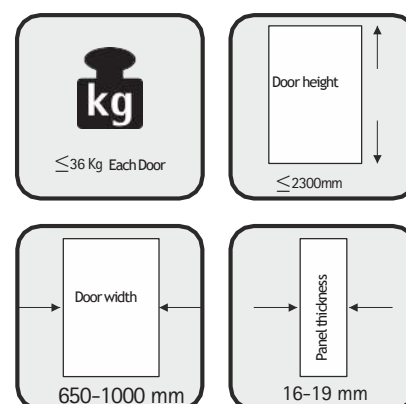
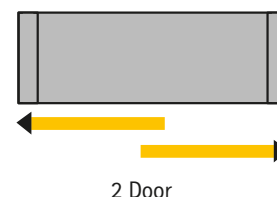

The Hand Book

Sliding & Folding

TopLine

Top running Doors

SlideLine

Bottom running Doors

WingLine

Folding Doors

RoomLine

Room Partition



Technik für Möbel

Hettich

SlideLine Grant 400 Neo

Bottom Running Doors

3600

Versatile 2/3 Door (Floor to Ceiling) Sliding system with Soft Closing.: SlideLine Grant 400 Neo



Salient Features

| | |
|-----------------------|--|
| Maximum Cabinet Width | 2000 mm |
| Description | Top Running Sliding door system for medium cabinets with 2 doors (35 kg) |
| Number of Tracks | 1 Top & 1 Bottom Track |
| Door Action | Horizontal |
| Door Position | Inset |
| Door Weight | 50 kg per Door |
| Door Height | 3500 mm Max. |
| Door Width | 1200 mm Max. |
| Door Thickness | 35 mm |
| Door Combinations | 2/3 Door Sliding |
| Silent Systems | Yes |
| Special Features | Inset Panels of 6/8/10 mm |

| Article No. | Description | Qty | Unit | PU | MRP |
|-------------|-----------------------|-----|------|----|------|
| 9 289 893 | Upper track- 3600 mm | 1 | Nos | 1 | 3201 |
| 9 289 894 | Upper track - 2400 mm | 1 | Nos | 1 | 2135 |
| 9 289 895 | Bottom track- 3600 mm | 1 | Nos | 1 | 1583 |
| 9 289 897 | Bottom track- 2400 mm | 1 | Nos | 1 | 1055 |

| Article No | Item Description | Height | Unit | PU | MRP |
|------------|---|---------|------|----|------|
| x xxx xxx | 1200 mm Wide Door without Transverse/Middle profile * | 3500 mm | Nos | 1 | 7409 |
| x xxx xxx | 1200 mm Wide Door 1 Transverse/Middle profile * | 3500 mm | Nos | 1 | 7922 |
| x xxx xxx | 1200 mm Wide Door with 2 Transverse/Middle profile * | 3500 mm | Nos | 1 | 8435 |
| x xxx xxx | 1200 mm Wide Door with 3 Transverse/Middle profile * | 3500 mm | Nos | 1 | 8948 |
| x xxx xxx | 1200 mm Wide Door with 4 Transverse/Middle profile * | 3500 mm | Nos | 1 | 9461 |
| x xxx xxx | 1200 mm Wide Door with 5 Transverse/Middle profile * | 3500 mm | Nos | 1 | 9974 |

*includes required set of Horizontal, Vertical, Transverse Profile & Silent System, Hanging Kit & Fitting materials)

Article Codes will be updated later

Soft Closing

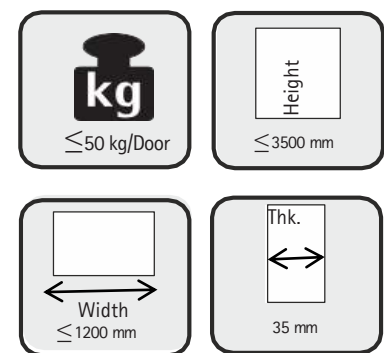
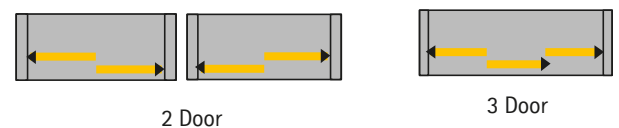

High end Single door Sliding system with Soft closing and Soft colliding mechanism: SlideLine M



| Salient Features | |
|-----------------------|---|
| Maximum Cabinet Width | 4000 mm |
| Description | Sliding door system on Single Track in Overlay position |
| Number of Tracks | 2 Track in 1 Runner |
| Door Action | Horizontal |
| Door Position | Overlay |
| Door Weight | 30 Kg per Door (Wood; Aluminum; Glass) |
| Door Height | 2000 mm Max. |
| Door Width | 300-2000 mm |
| Door Thickness | 16-25 mm |
| Door Combinations | 2/3 Door Sliding |
| Silent Systems | Soft Closing/ Soft Opening/ Soft Colliding |
| Special Features | Adjustment of Height +/- 2mm |

| Article No. | Description | Qty | Unit | PU | MRP |
|-------------|--|-----|------|----|-------|
| 9 209 225 | Profile Set SL-M 18/2500 mm 1 Profile | 1 | Set | 1 | 5833 |
| 9 209 277 | Decorative Silver Cover for 18 mm /2500 mm | 1 | Set | 1 | 2248 |
| 9 209 226 | Profile Set SL-M 18/4000 mm 1 Profile | 1 | Set | 1 | 8341 |
| 9 209 278 | Decorative Silver Cover for 18 mm /4000 mm | 1 | Set | 1 | 3214 |
| 9 209 228 | Profile Set SL-M 22/2500 mm 1 Profile | 1 | Set | 1 | 6155 |
| 9 209 229 | Profile Set SL-M 22/4000 mm 1 Profile | 1 | Set | 1 | 8985 |
| 9 209 287 | Decorative Silver Cover for 22 mm /4000 mm | 1 | Set | 1 | 3366 |
| 9 209 230 | Profile Set SL-M 25/2500 mm 1 Profile | 1 | Set | 1 | 6380 |
| 9 209 399 | Decorative Silver Cover for 25 mm /2500 mm | 1 | Set | 1 | 2362 |
| 9 209 231 | Profile Set SL-M 25/4000 mm 1 Profile | 1 | Set | 1 | 8978 |
| 9 209 400 | Decorative Silver Cover for 25 mm /4000 mm | 1 | Set | 1 | 3218 |
| 9 156 338 | Set fitting SlideLine M with Silent system for Wooden & 55 mm Alu. Profile Doors (Min. Width 450 mm ; Weight Max. 30kg; Self Thickness 16-25 mm) | 1 | Set | 1 | 7457 |
| 9 156 339 | Set fitting SlideLine M, for Wooden & 55mm Alu. Profile Doors (Min. Width 300 mm ; Weight Max. 30 kg; Self Thickness 16-25 mm) | 1 | Set | 1 | 4361 |
| 9 184 626 | Upgrade set for 19mm Alu. framed doors with Silent System | 1 | Set | 1 | 10922 |

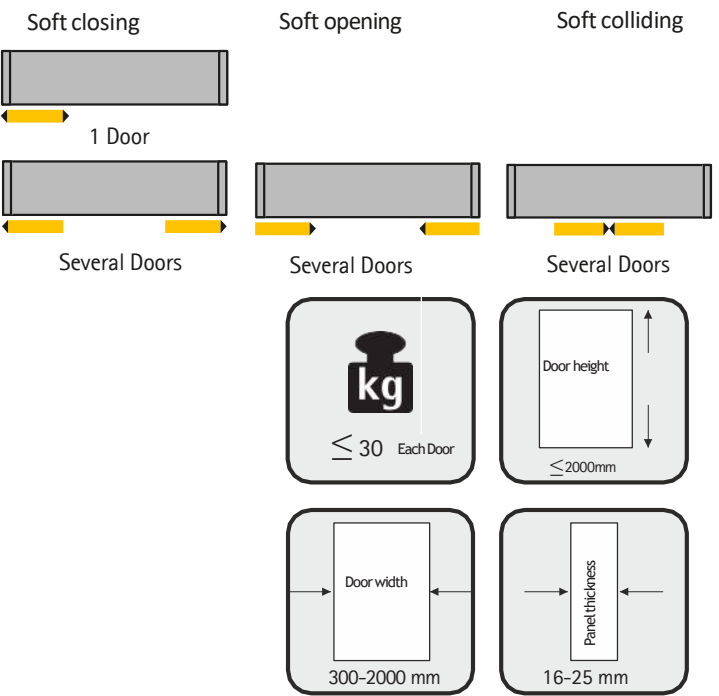

| Quality Criteria |
|---|
| Endurance test over 40,000 cycles (EN 15706 Level 3) |
| Closing test with a pulling force of 4 kg (EN 15706 Level 3) |
| Lift out test at 250 N (EN 15706 Level 3) |
| Load test in Horizontal direction at 250 N(EN 15706 Level 3) |
| Corrosion Test : 72 Hours Condensation Test (EN 6270) |

SlideLine 16

Bottom Running Doors

3000

Simple and economical Sliding solution for wardrobes and partitions : SlideLine 16



Salient Features

| | |
|-----------------------|---|
| Maximum Cabinet Width | 3000 mm |
| Description | Sliding door system on Twin Track in Inset position |
| Number of Tracks | 2 Track |
| Door Action | Horizontal |
| Door Position | Inset |
| Door Weight | 60 Kg per |
| Door Height | 2400 mm Max. |
| Door Width | 750-1500 mm |
| Door Thickness | 16-24 mm |
| Door Combinations | 2 Door Sliding |
| Silent Systems | Soft Closing |
| Special Features | Adjustment of Height +/- 4mm |

| Article No. | Description | Qty | Unit | PU | MRP |
|-----------------------------------|---|-----|------|----|-------------|
| For 2000 mm Cabinet | | | | | |
| 9 226 025 | Mounting Kit for SL 16 including Door Stops | 1 | Set | 1 | 1460 |
| 9 239 411 | Runner and Guide Profile 2000 mm | 1 | Set | 1 | 1745 |
| 9 226 028 | Soft Close Silent System | 1 | Set | 1 | 893 |
| SlideLine 16 (2000 mm) Set | | | | | 4098 |
| For 3000 mm Cabinet | | | | | |
| 9 226 025 | Mounting Kit for SL 16 including Door Stops | 1 | Set | 1 | 1460 |
| 9 226 026 | Runner and Guide Profile 3000 mm | 1 | Set | 1 | 3030 |
| 9 226 028 | Soft Close Silent System | 1 | Set | 1 | 893 |
| SlideLine 16 (3000 mm) Set | | | | | 5383 |

Quality Criteria

Endurance test over 20,000 cycles (EN 15706 Level 2)

Closing test with a pulling force of 3 kg (EN 15706 Level 2)

Lift out test at 200 N (EN 15706 Level 2)

Load test in Horizontal direction at 200N(EN 15706 Level 2)

Corrosion Test : 72 Hours Condensation Test (EN 6270)

Soft Closing

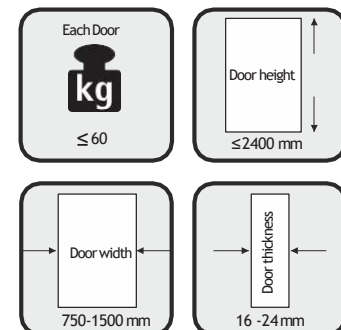

SlideLine 56

Bottom Running Doors

3000

Cost effective Inset sliding door solution for wider Cabinet : SlideLine 56



Salient Features

| | |
|-----------------------|---|
| Maximum Cabinet Width | 3000 mm |
| Description | Sliding door system on Runner/Guide Profile in Inset position |
| Number of Tracks | 2 Track |
| Door Action | Horizontal |
| Door Position | Inset |
| Door Weight | 40 Kg per Door(20 kg for Silent System) |
| Door Height | 2000 mm Max. |
| Door Width | 500-1500mm |
| Door Thickness | 16- 19 mm |
| Door Combinations | 2/3 Door Sliding |
| Silent Systems | Soft Closing for 2 Door Sliding |
| Special Features | |

| Article No. | Description | Qty | Unit | PU | MRP |
|--|--|-----|------|----|-------------|
| 2000 mm Profile for 1000 mm Cabinet | | | | | |
| 1 015 936 | Aluminium Runner Profile 2000 mm Silver | 2 | Pc | 16 | 592 |
| 0 045 324 | 2 Door Kit for 1 cabinet (16-19 mm thick door) | 1 | Set | 1 | 1617 |
| 9 079 731 | Add-On Silent System (max door weight 20kg) | 1 | Set | 1 | 3880 |
| SlideLine 56 2 Door (2000 mm) Set | | | | | 6089 |
| 1 015 936 | Aluminium Runner Profile 2000 mm Silver | 2 | Pc | 16 | 592 |
| 0 045 235 | 3 Door Kit for 1 cabinet (16-19 mm thick door) | 1 | Set | 1 | 2661 |
| 9 079 731 | Add-On Silent System (max door weight 20kg) | 1 | Set | 1 | 3880 |
| SlideLine 56 3 Door (2000 mm) Set | | | | | 7133 |
| 3000 mm Profile for 1500 mm Cabinet | | | | | |
| 0 071 110 | Aluminium Runner Profile 3000 mm Silver | 2 | Pc | 16 | 840 |
| 0 045 324 | 2 Door Kit for 1 cabinet (16-19 mm thick door) | 1 | Set | 1 | 1617 |
| 9 079 731 | Add-On Silent System (max door weight 20kg) | 1 | Set | 1 | 3880 |
| SlideLine 56 2 Door (3000 mm) Set | | | | | 6337 |
| 0 071 110 | Aluminium Runner Profile 3000 mm Silver | 2 | Pc | 16 | 840 |
| 0 045 235 | 3 Door Kit for 1 cabinet (16-19 mm thick door) | 1 | Set | 1 | 2661 |
| 9 079 731 | Add-On Silent System (max door weight 20kg) | 1 | Set | 1 | 3880 |
| SlideLine 56 2 Door (3000 mm) Set | | | | | 7381 |

Soft Closing

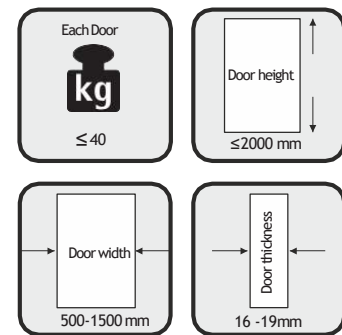
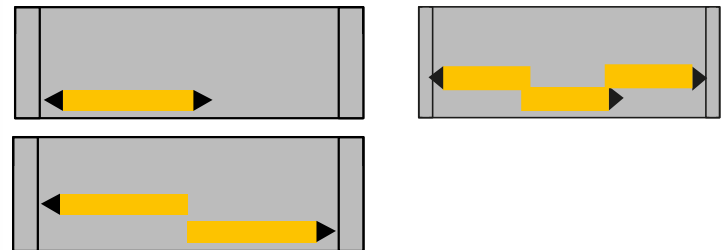

Quality Criteria

Endurance test over 40,000 cycles (EN 15706 Level 3)

Closing test with a pulling force of 4 kg (EN 15706 Level 3)

Lift out test at 250 N (EN 15706 Level 3)

Load test in Horizontal direction at 250N(EN 15706 Level 3)

SlideLine 55

Bottom Running Doors

2000

Cost efficient and reliable Sliding system for smaller cabinets:

SlideLine 55



Salient Features

| | |
|-----------------------|---|
| Maximum Cabinet Width | 2000 mm |
| Description | Sliding door system on Runner/Guide Profile in Inset position |
| Number of Tracks | 2 Track |
| Door Action | Horizontal |
| Door Position | Inset |
| Door Weight | 15 Kg per Door for PVC profile |
| Door Height | 1500 mm Max. |
| Door Width | 400-2000 mm |
| Door Thickness | 16-19 mm |
| Door Combinations | 2 Door Sliding |
| Silent Systems | Soft Closing for 2 Door Sliding |
| Special Features | |

| Article No. | Description | Qty | Unit | PU | MRP |
|--|---|-----|------|-----|-------------|
| 1 010 501 | PVC Runner Et Guide Profile Brown 4000 mm | 2 | Pc | 20 | 512 |
| 1 063 347 | Runner Component for 15 kg Door | 1 | Pc | 100 | 56 |
| 1 062 263 | Guide Component for 15 kg Door | 1 | Set | 100 | 69 |
| 0 047 392 | Door Stopper (Press in) | 1 | Set | 100 | 16 |
| 9 079 731 | Add-On Silent System (max door weight 20kg) | 1 | Set | 1 | 3880 |
| SlideLine 55 2 Door (2000 mm) Set | | | | | 4533 |

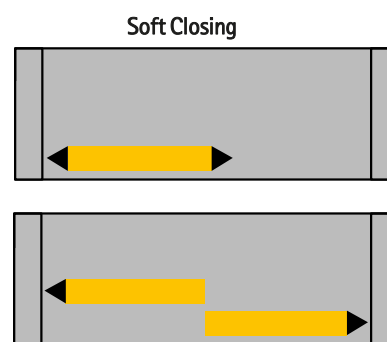

Quality Criteria

Endurance test over 40,000 cycles (EN 15706 Level 3)

Closing test with a pulling force of 4 kg (EN 15706 Level 3)

Lift out test at 250 N (EN 15706 Level 3)

Load test in Horizontal direction at 250N(EN 15706 Level 3)

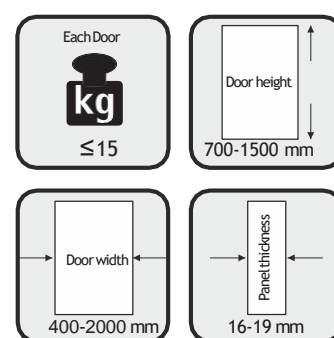

SlideLine 55 Plus

Bottom Running Doors

2000

Sophisticated and value added Sliding system for smaller cabinets: SlideLine 55Plus



Salient Features

| | |
|-----------------------|---|
| Maximum Cabinet Width | 2000 mm |
| Description | Sliding door system on Runner/Guide Profile in Inset position |
| Number of Tracks | 2 Track |
| Door Action | Horizontal |
| Door Position | Inset |
| Door Weight | 15-30 Kg for Aluminum profile |
| Door Height | 1500 mm Max. |
| Door Width | 400-2000 mm |
| Door Thickness | 16-19 mm |
| Door Combinations | 2 Door Sliding |
| Silent Systems | Soft Closing /Soft Opening for 2 Door Sliding |
| Special Features | Adjustment of Height +/- 1.5 mm |

| Article No. | Description | Qty | Unit | PU | MRP |
|--|--|-----|------|-----|-------------|
| 1 057 668 | PVC Runner & Guide Profile Brown 4000 mm | 1 | Pc | 4 | 1104 |
| 9 115 219 | Runner Component for 15 kg Door | 1 | Pc | 100 | 267 |
| 9 115 217 | Guide Component for 15 kg Door | 1 | Set | 100 | 117 |
| 9 115 216 | Spacer STB 55 Plus | 1 | Set | 100 | 51 |
| 9 119 584 | Silent System (Left Door) | 1 | Set | 30 | 1048 |
| 9 119 585 | Silent System (Right Door) | 1 | Set | 30 | 1048 |
| 9 118 477 | Assembly Activator Silent System | 1 | Set | 300 | 93 |
| SlideLine 55 Plus Set (For 1000 mm Cabinet) | | | | | 3728 |

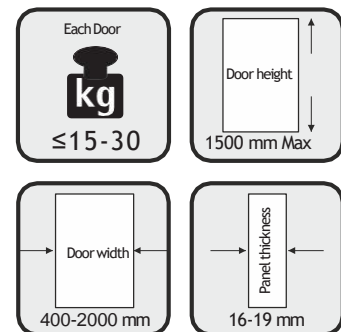
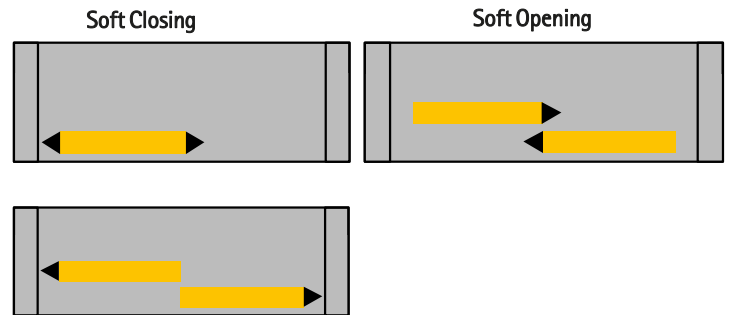

Quality Criteria

Endurance test over 40,000 cycles (EN 15706 Level 3)

Closing test with a pulling force of 4kg (EN 15706 Level 3)

Lift out test at 250 N (EN 15706 Level 3)

Load test in Horizontal direction at 250N(EN 15706 Level 3)

SlideLine 97

Bottom Running Doors

5000

Smoothest Sliding solution for Glass doors:

SlideLine 97



Salient Features

| | |
|------------------------------|---|
| Maximum Cabinet Width | 5000 mm |
| Description | Sliding door system for Glass on Runner/Guide Profile in Inset position |
| Number of Tracks | 2 Track |
| Door Action | Horizontal |
| Door Position | Inset |
| Door Weight | 25 kg (with 2 Running Parts/50 Kg (With 4 Running Parts) |
| Door Height | 2800 mm Max. |
| Door Width | 250-2500 mm |
| Door Thickness | 5/6/8 mm Glass |
| Door Combinations | 2 Door Sliding |
| Silent Systems | Dampner |
| Special Features | |

| Article No. | Description | Qty | Unit | PU | MRP |
|---|---|-----|------|----|--------------|
| SlideLine 97 (2 Glass Door Sliding) | | | | | |
| 0 048 965 | Slide-Line 97 Guide profile 2500 mm | 1 | Set | 4 | 6059 |
| 0 048 966 | Slide-Line 97 Running Shoe 2500 mm | 1 | Set | 4 | 4694 |
| 0 076 472 | Slide-Line 97 Running Gear | 4 | Pc | 4 | 734 |
| 0 076 475 | Slide-Line 97 Stop & Securing Device | 4 | Pc | 10 | 284 |
| 0 048 970 | Slide-Line 97 Dust Prevention Profile 2500 mm | 2 | Pc | 40 | 2756 |
| 0 048 971 | Frame Runner Profile | 1 | Pc | 30 | 4369 |
| 0 076 480 | Slide-Line 97 End Plate, Chrome | 4 | Pc | 10 | 278 |
| 0 048 969 | Slide-Line 97 Frame 2500 mm | 4 | Pc | 4 | 4199 |
| 0 048 968 | Slide in profile for 6 mm | 1 | Pc | 4 | 1000 |
| 0 076 484 | Special Fitting Tool | 1 | Pc | 1 | 4612 |
| SlideLine 97 (2 Glass Door Sliding) | | | | | 28985 |
| Accessories | | | | | |
| 0 076 481 | Slide-Line 97 Running component handle | 2 | Pc | 10 | 946 |
| 0 076 482 | Adapter, Chrome | 1 | Set | 1 | 1617 |
| 0 076 483 | Pressure Plug Lock | 1 | Set | 1 | 5473 |

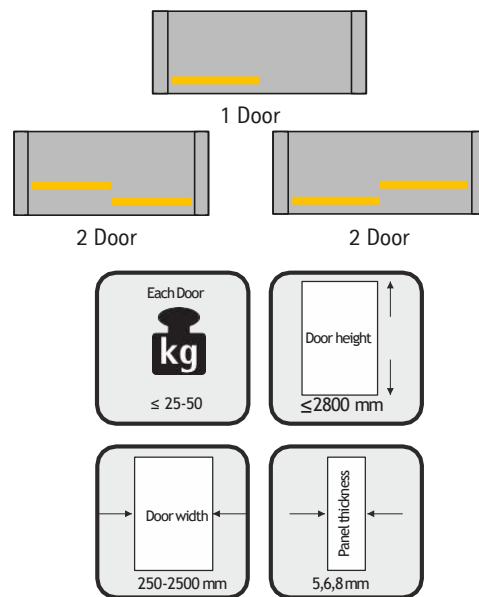

Quality Criteria

Endurance test over 40,000 cycles (EN 15706 Level 3)

Closing test with a pulling force of 4kg (EN 15706 Level 3)

Lift out test at 250 N (EN 15706 Level 3)

Load test in Horizontal direction at 250N(EN 15706 Level 3)

Retractable door system. Doors that disappears when opened completely: KA 5740 (Pocket Sliding)



| Salient Features | |
|-----------------------|-----------------------------------|
| Maximum Cabinet Width | 1400 mm |
| Description | Retractable Doors based on Slides |
| Number of Tracks | No Tracks; 2 Sets of KA 5740 |
| Door Action | Horizontal |
| Door Position | Overlay |
| Door Weight | 14 kg Max |
| Door Height | 1800 mm Max. |
| Door Width | 300-700 mm |
| Door Thickness | 16-32 mm |
| Door Combinations | 1/2 Door Sliding |
| Silent Systems | No |
| Special Features | |

| Article No. | Description | Qty | Unit | PU | MRP |
|-------------|-------------|-----|------|----|------|
| KA 5740 | | | | | |
| 0 041 371 | 300 mm | 1 | Set | 1 | 1065 |
| 0 041 372 | 350 mm | 1 | Set | 1 | 1282 |
| 0 041 373 | 400 mm | 1 | Set | 1 | 1356 |
| 0 041 374 | 450 mm | 1 | Set | 1 | 1409 |
| 0 041 375 | 500 mm | 1 | Set | 1 | 1478 |
| 0 041 376 | 550 mm | 1 | Set | 1 | 1536 |
| 0 041 377 | 600 mm | 1 | Set | 1 | 1605 |
| 0 041 378 | 650 mm | 1 | Set | 1 | 1517 |
| 0 041 379 | 700 mm | 1 | Set | 1 | 1737 |

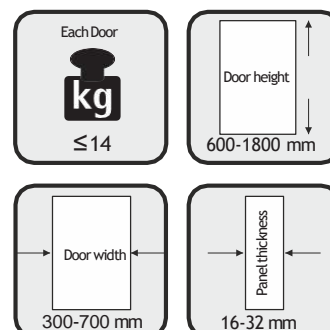

| Article No. | Description | Qty | Unit | PU | MRP |
|-------------|-----------------------|-----|------|----|-----|
| 9 079 526 | KA 5740 Accessory Set | 1 | Set | 1 | 415 |

Quality Criteria

Conforms to ANSI/BHMA X 5.5 Standard

Synchronous Sliding Opening of two vertical door with one movement: Vertico Synchro/Mono



Salient Features

| | |
|-----------------------|--|
| Maximum Cabinet Width | 1500 mm |
| Description | Vertically Synchronous Wooden/Aluminium Door |
| Number of Tracks | No Tracks; 2 Sets of KA 5740 |
| Door Action | Vertically Synchronous Wooden/Aluminium Door |
| Door Position | Inset |
| Door Weight | 15 kg Max |
| Door Height | 300-700 mm |
| Door Width | 1500 mm |
| Door Thickness | 16 mm and above |
| Door Combinations | 2 Door sliding |
| Silent Systems | No |
| Special Features | |

| Article No. | Description | Qty | Unit | PU | MRP |
|----------------------------|--|-----|------|----|--------------|
| Vertico Synchro Set | | | | | |
| 0 020 386 | Vertico Synchro Set 400 for Overlay Door height 400-600 mm | 1 | Set | 1 | 24313 |
| 0 020 400 | Cover Profile 2500 mm Aluminium Silver anodised | 2 | Pc | 1 | 3484 |
| Vertico Synchro Set | | | | | 27797 |
| Vertico Mono Set | | | | | |
| 0 043 315 | Set Vertico Mono for inset door | 1 | Set | 1 | 20475 |
| 0 020 400 | Cover Profile 2500 mm Aluminium Silver anodised | 2 | Pc | 1 | 3484 |
| Vertico Mono Set | | | | | 23959 |

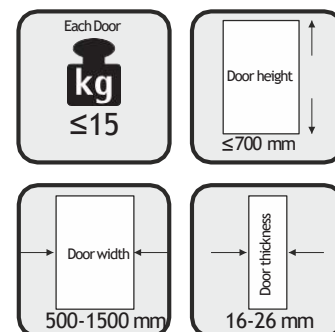
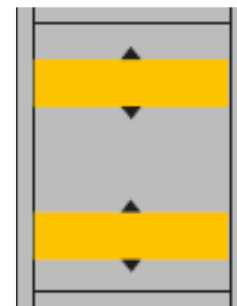

Quality Criteria

Endurance test over 20,000 cycles (EN 15706 Level 2)

Closing test with a pulling force of 3 kg (EN 15706 Level 2)

Lift out test at 200 N (EN 15706 Level 2)

Load test in Horizontal direction at 200 N(EN 15706 Level 2)

Corrosion Test : 72 Hours Condensation Test (EN 6270)

The Hand Book

Sliding & Folding

TopLine

Top running Doors

SlideLine

Bottom running Doors

WingLine

Folding Doors

RoomLine

Room Partition



Technik für Möbel

Hettich

Experience Widest Panoramic opening of a Folding Door system :

WingLine L



Salient Features

| | |
|-----------------------|---|
| Maximum Cabinet Width | 2400 mm |
| Description | Folding door system on Runner Profile in Inset position |
| Number of Tracks | 1 Track |
| Door Action | Horizontal |
| Door Position | Overlay |
| Door Weight | 5-25 kg per door |
| Door Height | 2400 mm Max. |
| Door Width | 250-600 mm |
| Door Thickness | 16-25 mm |
| Door Combinations | Un assisted Opening/Closing; Pull to Move; Push to Move |
| Silent Systems | Soft Closing for Pull to Move |
| Special Features | 3 D Adjustment +/- 2to3 mm |

| Article No. | Description | Qty | Unit | PU | MRP |
|---|--|-----|------|----|--------------|
| WingLine L Push to Move (5-12 kg Door) | | | | | |
| 9 237 917 | Top Runner Profile 2400 mm (for 5-12 Kg Door) | 1 | Set | 1 | 2256 |
| 9 237 901 | WingLine Kit (Left) | 1 | Set | 1 | 2044 |
| 9 237 900 | WingLine Kit (Right) | 1 | Set | 1 | 2044 |
| 9 238 051 | Push to Move Mechanism (Medium) - Left | 1 | Set | 1 | 8133 |
| 9 238 101 | Push to Move Mechanism (Medium) - Right | 1 | Set | 1 | 8133 |
| 9 237 758 | Profile Mounting Clip | 1 | Set | 1 | 188 |
| WingLine L Push to Move (5-12 kg Door) Set | | | | | 22798 |
| WingLine L Push to Move (12-25 kg Door) | | | | | |
| 9 239 310 | Top Runner Profile 2400 mm (for 12-25 Kg Door) | 1 | Set | 1 | 3764 |
| 9 237 880 | WingLine Kit (Left) | 1 | Set | 1 | 3414 |
| 9 237 881 | WingLine Kit (Right) | 1 | Set | 1 | 3414 |
| 9 238 052 | Push to Move Mechanism (Heavy) - Left | 1 | Set | 1 | 7976 |
| 9 238 053 | Push to Move Mechanism (Heavy) - Right | 1 | Set | 1 | 7976 |
| WingLine L Push to Move (12-25 kg Door) Set | | | | | 26544 |
| WingLine L Pull to Move (5-12 kg Door) | | | | | |
| 9 237 917 | Top Runner Profile 2400 mm (for 5-12 Kg Door) | 1 | Set | 1 | 2256 |
| 9 237 901 | WingLine Kit (Left) | 1 | Set | 1 | 2044 |
| 9 237 900 | WingLine Kit (Right) | 1 | Set | 1 | 2044 |
| 9 238 115 | Pull to Move Mechanism (Medium) - Left | 1 | Set | 1 | 8133 |
| 9 238 101 | Pull to Move Mechanism (Medium) - Right | 1 | Set | 1 | 8133 |
| 9 237 758 | Profile Mounting Clip | 1 | Set | 1 | 188 |
| WingLine L Pull to Move (5-12 kg Door) Set | | | | | 22798 |
| WingLine L Pull to Move (12-25 kg Door) | | | | | |
| 9 239 310 | Top Runner Profile 2400 mm (for 12-25 Kg Door) | 1 | Set | 1 | 3764 |
| 9 237 880 | WingLine Kit (Left) | 1 | Set | 1 | 3414 |
| 9 237 881 | WingLine Kit (Right) | 1 | Set | 1 | 3414 |
| 9 238 125 | Pull to Move Mechanism (Heavy) - Left | 1 | Set | 1 | 7976 |
| 9 238 114 | Push to Move Mechanism (HEavy) - Right | 1 | Set | 1 | 7976 |
| WingLine L Pull to Move (12-25 kg Door) Set | | | | | 26544 |
| WingLine L Pull to Move with Silent System (5-12 kg Door) | | | | | |
| 9 237 917 | Top Runner Profile 2400 mm (for 5-12 Kg Door) | 1 | Set | 1 | 2256 |
| 9 237 903 | WingLine Kit (Left) | 1 | Set | 1 | 2044 |
| 9 237 902 | WingLine Kit (Right) | 1 | Set | 1 | 2044 |
| 9 238 121 | Pull to Move Silent Mechanism (Medium) - Left | 1 | Set | 1 | 6577 |
| 9 238 124 | Pull to Move Silent Mechanism (Medium) - Right | 1 | Set | 1 | 6577 |
| 9 237 758 | Profile Mounting Clip | 1 | Set | 1 | 188 |
| WingLine L Pull to Move with Silent System (5-12 kg Door) Set | | | | | 19686 |
| WingLine L Pull to Move with Silent System (12-25 kg Door) | | | | | |
| 9 239 310 | Top Runner Profile 2400 mm (for 12-25 Kg Door) | 1 | Set | 1 | 3764 |
| 9 237 852 | WingLine Kit (Left) | 1 | Set | 1 | 3414 |
| 9 237 890 | WingLine Kit (Right) | 1 | Set | 1 | 3414 |
| 9 238 123 | Pull to Move Silent Mechanism (Heavy) - Left | 1 | Set | 1 | 7341 |
| 9 238 122 | Push to Move Silent Mechanism (Heavy) - Right | 1 | Set | 1 | 7341 |
| WingLine L Pull to Move with Silent System (12-25 kg Door) Set | | | | | 25274 |

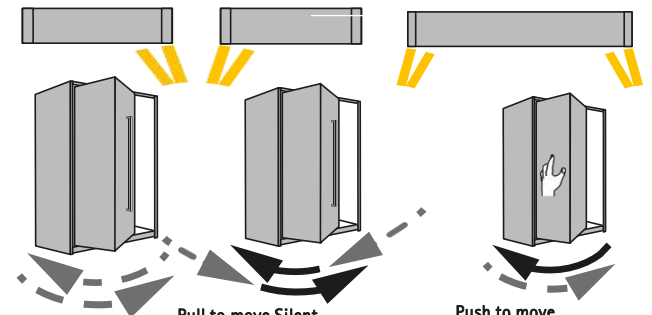

No opening mechanism
The door is opened and closed by hand.

Pull to move Silent
The door opens automatically from a 35° opening angle in response to a slight pull on the handle and is returned to the closed position in a soft closing movement.

Push to move
The door opens automatically in response to a light press on the front and is returned to the closed position by hand.

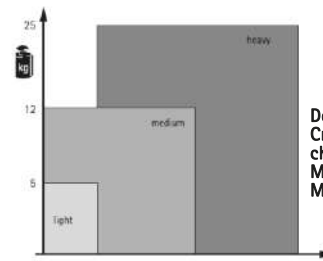

Door Weight Criteria to choose Pull to Move & Push to Move Mechanism

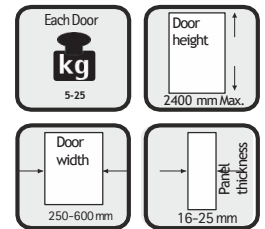

Auto Closing Hinges for Doors to be ordered separately

Quality Criteria

Endurance test over 40,000 cycles (EN 15706 Level 3)

Closing test with a pulling force of 4 kg (EN 15706 Level 3)

Lift out test at 250 N (EN 15706 Level 3)

Load test in Horizontal direction at 250N(EN 15706 Level 3)

Corrosion Test : 72 Hours Condensation Test (EN 6270)

Wing 170

Folding Doors

1200

Space saving, Corner Folding door system : WingLine 170



Salient Features

| | |
|-----------------------|------------------------------------|
| Maximum Cabinet Width | 1200 mm |
| Description | 1 Folding Door (2 Wings) |
| Number of Tracks | 1 Track |
| Door Action | Horizontal |
| Door Position | Overlay |
| Door Weight | Weight Carrying capacity of Hinges |
| Door Height | 1000-2200 mm |
| Door Width | 300 mm Max |
| Door Thickness | 16-19 mm |
| Door Combinations | 2 Door sets of 2 Doors each |
| Silent Systems | As per Silent System of Hinges |
| Special Features | |

| Article No. | Description | Qty | Unit | PU | MRP |
|---|------------------|-----|------|----|-------------|
| 0 074 658 | WingLine 170 | 1 | Pc | | 1289 |
| 0 071 648 | Centre Hinge 648 | 2 | Pc | | 70 |
| WingLine 170 Set (For 1 door Set of 2 doors) | | | | | 1359 |

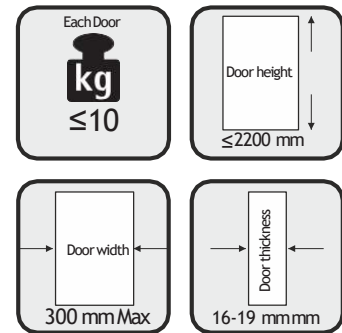
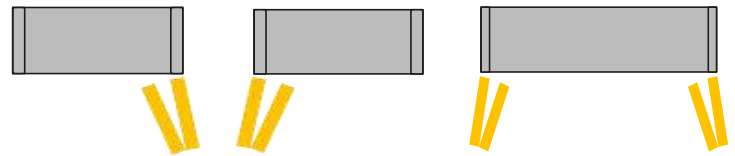

Quality Criteria

Endurance test over 40,000 cycles (EN 15706 Level 3)

Closing test with a pulling force of 4 kg (EN 15706 Level 3)

Lift out test at 250 N (EN 15706 Level 3)

Load test in Horizontal direction at 250 N(EN 15706 Level 3)

Corrosion Test : 72 Hours Condensation Test (EN 6270)

Versatile folding door solution – Wardrobes with moving Door sets : Wing 77 (Moveable Doors)



Salient Features

| | |
|-----------------------|--|
| Maximum Cabinet Width | 2000 mm |
| Description | Folding door system (Free Moving) on Runner Profile in Overlay position |
| Number of Tracks | 1 Track |
| Door Action | Horizontal |
| Door Position | Overlay |
| Door Weight | 20-25 kg per door |
| Door Height | 2400 mm Max. |
| Door Width | 400-500 mm |
| Door Thickness | 16-19 mm |
| Door Combinations | Free Moving 2 Door sets of 2 Doors |
| Silent Systems | No |
| Special Features | Height Adjustment +/- 3 mm |

| Article No. | Description | Qty | Unit | PU | MRP |
|---|--|-----|------|----|--------------|
| WingLine 77 (Set of 2 Wings (1 Door Set)) | | | | | |
| 0 070 986 | Set of 2 Wings (1 Door Set) 25kg/Door | 1 | Set | 1 | 8700 |
| 0 070 985 | Aluminium Guide Profile (3200mm) | 1 | Pc | 4 | 4103 |
| 9 193 574 | Aluminium Runner Profile (3200mm) | 1 | Pc | 4 | 4619 |
| WingLine 77 (2 Wings Set) | | | | | 17422 |
| WingLine 77 (Set of 4 Wings (2 Door Sets)) | | | | | |
| 0 070 987 | Set of 4 Wings (2 Door Sets) 20kg/Door | 1 | Set | 1 | 15765 |
| 0 070 985 | Aluminium Guide Profile (3200mm) | 1 | Pc | 4 | 4103 |
| 9 193 574 | Aluminium Runner Profile (3200mm) | 1 | Pc | 4 | 4619 |
| WingLine 77 (4 Wings Set) | | | | | 24487 |

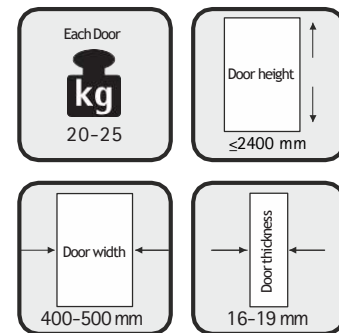

Quality Criteria

Endurance test over 40,000 cycles (EN 15706 Level 3)

Closing test with a pulling force of 4 kg (EN 15706 Level 3)

Lift out test at 250 N (EN 15706 Level 3)

Load test in Horizontal direction at 250N(EN 15706 Level 3)

Corrosion Test : 72 Hours Condensation Test (EN 6270)

Universal both side folding door system for Walk-in Wardrobe : WingLine 230



Salient Features

| | |
|-----------------------|---------------------------------------|
| Maximum Cabinet Width | 2400 mm |
| Description | Folding door system on Runner Profile |
| Number of Tracks | 1 Track |
| Door Action | Horizontal |
| Door Position | Overlay |
| Door Weight | 20-25 kg per door |
| Door Height | 3000 mm |
| Door Width | 400-600 mm |
| Door Thickness | 16-25 mm |
| Door Combinations | Left & Right Side Folding Door Set |
| Silent Systems | No |
| Special Features | Height Adjustment +/- 3 mm |

| Article No. | Description | Qty | Unit | PU | MRP |
|---|--|-----|------|----|--------------|
| WingLine 230 Set of 4 Wings (2 Left & 2 Right)) | | | | | |
| 0 079 013 | Runner profile Aluminium White 2400 mm | 1 | Pc | 4 | 7285 |
| 0 079 015 | WingLine 230 Set of 4 Wings (Left & Right) (16-25 mm Door thickness) | 1 | Set | 1 | 23498 |
| WingLine 230 Set(4 Wings Set) | | | | | 30783 |

Auto Closing Hinges for Doors to be ordered separately

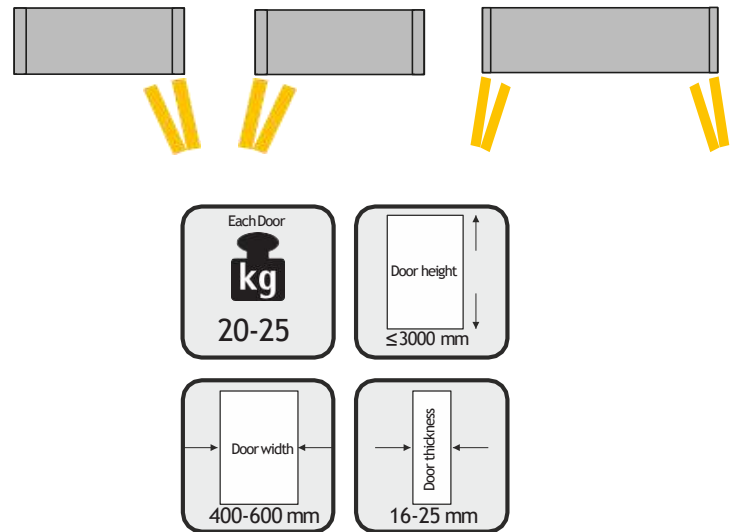

Quality Criteria

Endurance test over 40,000 cycles (EN 15706 Level 3)

Closing test with a pulling force of 4 kg (EN 15706 Level 3)

Lift out test at 250 N (EN 15706 Level 3)

Load test in Horizontal direction at 250 N(EN 15706 Level 3)

Corrosion Test : 72 Hours Condensation Test (EN 6270)

Horizon Plus

Folding Doors

700 x 700

Space saving Corner Solution : Swing-to-side doors for corner wardrobes: Horizon Plus



Salient Features

| | |
|------------------------------|--|
| Maximum Cabinet Width | 700 x 700 (Corner Cabinet) 1400 mm (Straight Cabinet) |
| Description | Top & Bottom Pivot based Swivel System |
| Number of Tracks | No Track; Pivot Based |
| Door Action | Horizontal |
| Door Position | Overlay |
| Door Weight | 20 kg per Door |
| Door Height | 2600 mm Max. |
| Door Width | Door width 400- 700 mm (With Door Protrusion) Door width 445- 583 mm (No Door Protrusion) |
| Door Thickness | 16-26 mm |
| Door Combinations | 1/2 Door Swivel |
| Silent Systems | No |
| Special Features | Height : +4mm/ Width: +/- 2mm, Tilt :+4mm |

| Article No. | Description | Qty | Unit | PU | MRP |
|------------------------------|--|-----|------|----|-------|
| Horizon Plus Single Door Kit | | | | | |
| 9 080 210 | Horizon Plus Single Door Kit for internal height 2570 mm and Door Width 400-515 mm | 1 | Set | 1 | 44012 |
| 0 048 078 | Horizon Plus Single Door Kit for internal height 2570 mm and Door Width 475-700 mm | 1 | Set | 1 | 41659 |

Quality Criteria

Endurance test over 40,000 cycles (EN 15706 Level 3)

Closing test with a pulling force of 4 kg (EN 15706 Level 3)

Lift out test at 250 N (EN 15706 Level 3)

Load test in Horizontal direction at 250N(EN 15706 Level 3)

Corrosion Test : 72 Hours Condensation Test (EN 6270)

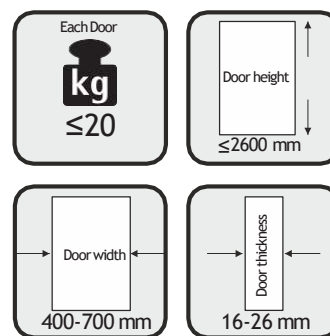

The Hand Book

Sliding & Folding

TopLine

Top running Doors

SlideLine

Bottom running Doors

WingLine

Folding Doors

RoomLine

Room Partition



Technik für Möbel

Hettich

Universal Single sliding Door system for room partition:

TopLine 80



Salient Features

| | |
|-------------------|---------------------------------------|
| Maximum Wall Gap | 1500 mm |
| Description | Sliding door system on Runner Profile |
| Number of Tracks | 1 Track |
| Door Action | Horizontal |
| Door Mount | Wall/Ceiling |
| Door Weight | 80 kg per door |
| Door Height | 3000 mm |
| Door Width | 1500 mm Max |
| Door Thickness | 25.4 mm |
| Door Combinations | Single Door ; Left or Right Movement |
| Silent Systems | Soft Closing & Soft Opening |
| Special Features | Height Adjustment +/- 8 mm |

| Article No. | Description | Qty | Unit | PU | MRP |
|--------------------------------------|--|-----|------|----|-------------|
| TopLine 80 with Silent System | | | | | |
| 9 289 654 | Hanging Roller Sliding System with Opening & Closing Dampener with Bottom Guide for 1 Door | 1 | Set | 1 | 4769 |
| 9 289 905 | Aluminium Runner Profile 2000 mm | 1 | Set | 4 | 1580 |
| 9 289 655 | Wall Angle Bracket | 1 | Set | 1 | 173 |
| TopLine 80 Silent System (2000 mm) | | | | | 6522 |
| 9 289 654 | Hanging Roller Sliding System with Opening & Closing Dampener with Bottom Guide for 1 Door | 1 | Set | 1 | 4769 |
| 9 289 904 | Aluminium Runner Profile 3000 mm | 1 | Set | 4 | 2206 |
| 9 289 655 | Wall Angle Bracket | 1 | Set | 1 | 173 |
| TopLine 80 Silent System (3000 mm) | | | | | 7148 |
| TopLine 80 | | | | | |
| 9 089 915 | TopLine 80 Assembly Kit | 1 | Set | 1 | 3143 |
| 9 089 914 | Aluminium Runner Profile 2000 mm | 1 | Set | 1 | 1580 |
| TopLine 80 (2000 mm) | | | | | 4723 |
| 9 089 915 | TopLine 80 Assembly Kit | 1 | Set | 1 | 3143 |
| 9 083 102 | Aluminium Runner Profile 3000 mm | 1 | Set | 1 | 2206 |
| TopLine 80 (3000 mm) | | | | | 5349 |

Single

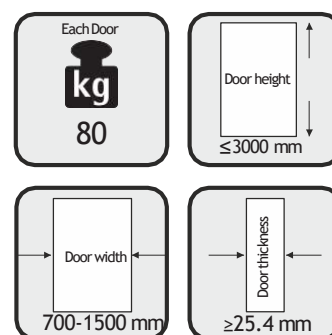
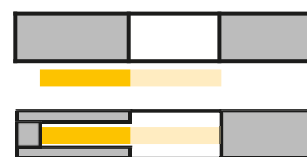

Quality Criteria

- Endurance test over 20,000 cycles (EN 15706 Level 2)
- Closing test with a pulling force of 3 kg (EN 15706 Level 2)
- Lift out test at 200 N (EN 15706 Level 2)
- Load test in Horizontal direction at 200N(EN 15706 Level 2)
- Corrosion Test : 72 Hours Condensation Test (EN 6270)**

Universal Single Sliding system for heavy Room partition doors: TopLine Grant 1230



Salient Features

| | |
|-------------------|--|
| Maximum Wall Gap | 1800 mm |
| Description | Sliding door system on Runner Profile |
| Number of Tracks | 1 Track |
| Door Action | Horizontal |
| Door Mount | Ceiling |
| Door Weight | 147 kg per door |
| Door Height | 3000 mm |
| Door Width | 1800 mm Max |
| Door Thickness | 25.4 mm Minimum |
| Door Combinations | Single Door, Bi Passing Door Bi Parting Door |
| Silent Systems | No |
| Special Features | Height Adjustment +/- 12 mm |

| Article No. | Description | Qty | Unit | PU | MRP |
|-------------------------------------|-----------------------------|-----|------|----|--------------|
| Grant 1230 (3000 mm) | | | | | |
| 0 050 125 | Runner Profile 3000 mm | 1 | Pc | 4 | 4321 |
| 0 048 295 | Grant 1230 Installation Kit | 1 | Set | 1 | 5920 |
| 0 050 140 | Bumper Stop | 1 | Pc | 2 | 1021 |
| 0 050 562 | Floor Guide | 1 | Pc | 10 | 373 |
| TopLine Grant 1230 (3000 mm) | | | | | 11635 |
| Grant 1230 (3600 mm) | | | | | |
| 0 050 126 | Runner Profile 3600 mm | 1 | Pc | 4 | 6324 |
| 0 048 295 | Grant 1230 Installation Kit | 1 | Set | 1 | 5920 |
| 0 050 140 | Bumper Stop | 1 | Pc | 2 | 1021 |
| 0 050 562 | Floor Guide | 1 | Pc | 10 | 373 |
| TopLine Grant 1230 (3600 mm) | | | | | 13638 |

Quality Criteria

Conforms to ANSI/BHMA Standard Grade 1

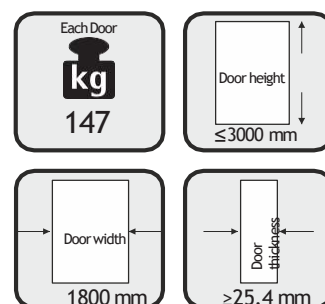

Single

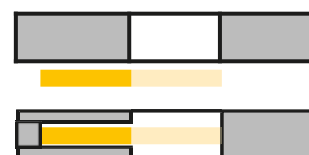

Bi-parting

Use additional set of Runner and Kit

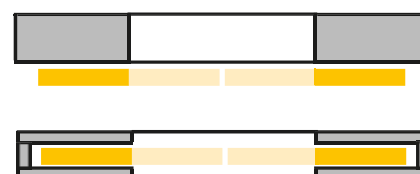

By-passing

Mounting two parallel tracks

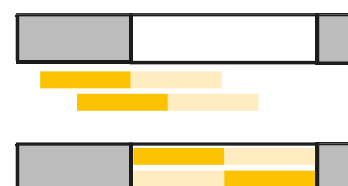

Sliding System with Soft Closing & Opening system for partition Doors : Topline Grant SD



Salient Features

| | |
|-------------------|--|
| Maximum Wall Gap | 1500/1800 mm |
| Description | Sliding door system on Runner Profile |
| Number of Tracks | 1 Track |
| Door Action | Horizontal |
| Door Mount | Wall/Ceiling |
| Door Weight | 68 kg per door |
| Door Height | 3000 mm |
| Door Width | 1800 mm Max |
| Door Thickness | 25 mm Minimum |
| Door Combinations | Single Door, Bi Passing Door Bi Parting Door |
| Silent Systems | Soft Closing & Soft Opening |
| Special Features | Height Adjustment +/- 12 mm |

| Article No. | Description | Qty | Unit | PU | MRP |
|---|-------------------------------------|-----|------|----|--------------|
| TopLine Grant SD Standard (10 ft / 3000 mm) | | | | | |
| 9199839 | SD Runner Profile 10 feet (3000 mm) | 1 | Pc | 1 | 15748 |
| 9191124 | SD Standard Installation Kit | 1 | Set | 1 | 7136 |
| 9235608 | Silent System SD | 1 | Pc | 1 | 13786 |
| | | | | | 36670 |
| TopLine Grant SD Low Profile (10 ft / 3000 mm) | | | | | |
| 9199839 | SD Runner Profile 10 feet (3000 mm) | 1 | Pc | 1 | 15748 |
| 9203725 | SD Low Profile Installation Kit | 1 | Set | 1 | 25053 |
| 9235608 | Silent System SD | 1 | Pc | 1 | 13786 |
| | | | | | 54587 |
| TopLine Grant SD Standard (12 ft / 3600 mm) | | | | | |
| 9199840 | SD Runner Profile 12 feet (3600 mm) | 1 | Pc | 1 | 18897 |
| 9191124 | SD Standard Installation Kit | 1 | Set | 1 | 7136 |
| 9235608 | Silent System SD | 1 | Pc | 1 | 13786 |
| | | | | | 39819 |
| TopLine Grant SD Low Profile (12 ft / 3600 mm) | | | | | |
| 9199840 | SD Runner Profile 12 feet (3600 mm) | 1 | Pc | 1 | 18897 |
| 9203725 | SD Low Profile Installation Kit | 1 | Set | 1 | 25053 |
| 9235608 | Silent System SD | 1 | Pc | 1 | 13786 |
| | | | | | 57736 |
| Accessories | | | | | |
| 9203751 | Header mount Fascia Clip | 1 | Pc | 1 | 1109 |
| 9202941 | End cap without fascia | 1 | Pc | 1 | 2176 |
| 9203733 | Front fascia (8 feet) | 1 | Pc | 1 | 9693 |

Quality Criteria

Conforms to ANSI/BHMA Standard Grade 1

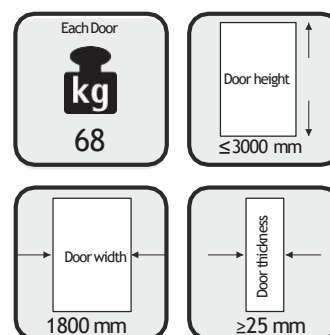

Single



Bi-parting

Use additional set of Runner and Kit

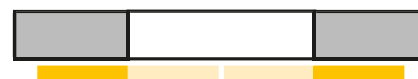

By-passing

Mounting two parallel tracks



Sliding System with Soft Closing & Opening for Medium heavy Doors : Topline Grant HD



Salient Features

| | |
|-------------------|--|
| Maximum Wall Gap | 1500/1800 mm |
| Description | Sliding door system on Runner Profile |
| Number of Tracks | 1 Track |
| Door Action | Horizontal |
| Door Mount | Wall/Ceiling |
| Door Weight | 147 kg per door |
| Door Height | 3000 mm |
| Door Width | 1800 mm Max |
| Door Thickness | 25 mm Minimum |
| Door Combinations | Single Door, Bi Passing Door Bi Parting Door |
| Silent Systems | Soft Closing & Soft Opening |
| Special Features | Height Adjustment +/- 12 mm |

| Article No. | Description | Qty | Unit | PU | MRP |
|---|-----------------------------------|-----|------|----|--------------|
| TopLine Grant HD Standard (10 ft/3000 mm) | | | | | |
| 9 201 461 | HD Runner Profile 3000 mm (10 ft) | 1 | Pc | 1 | 14472 |
| 9 191 125 | HD Standard Installation Kit | 1 | Set | 1 | 7879 |
| 9 235 621 | HD Silent System Set | 1 | Pc | 1 | 16575 |
| Topline Grant HD Standard (10ft/3000 mm) | | | | | 38926 |
| TopLine Grant HD Low Profile (10 ft/3000 mm) | | | | | |
| 9 201 461 | HD Runner Profile 3000 mm (10 ft) | 1 | Pc | 1 | 14472 |
| 9 203 729 | HD Low Profile Installation Kit | 1 | Set | 1 | 25072 |
| 9 235 621 | HD Silent System Set | 1 | Pc | 1 | 16575 |
| Topline Grant HD Low Profile (10ft/3000 mm) | | | | | 56119 |
| TopLine Grant HD Standard (12 ft/3600 mm) | | | | | |
| 9201462 | HD Runner Profile 3600 mm (12 ft) | 1 | Pc | 1 | 17349 |
| 9191125 | HD Standard Installation Kit | 1 | Set | 1 | 7879 |
| 9235621 | HD Silent System Set | 1 | Pc | 1 | 16575 |
| Topline Grant HD Standard (12ft/3600 mm) | | | | | 41803 |
| TopLine Grant HD Low Profile (12 ft/3600 mm) | | | | | |
| 9201462 | HD Runner Profile 3600 mm (12 ft) | 1 | Pc | 1 | 17349 |
| 9203729 | HD Low Profile Installation Kit | 1 | Set | 1 | 25072 |
| 9235621 | HD Silent System Set | 1 | Pc | 1 | 16575 |
| Topline Grant HD Standard (12ft/3600 mm) | | | | | 58996 |
| Accessories | | | | | |
| 9 203 751 | Mount Clip Header for Fascia | 1 | Pc | 1 | 1109 |
| 9 202 942 | End Cap for HD Profile | 1 | Pc | 1 | 1990 |

Quality Criteria

Conforms to ANSI/BHMA Standard Grade 1

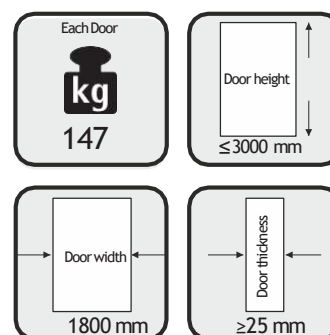

Single



Bi-parting

Use additional set of Runner and Kit



By-passing

Mounting two parallel tracks

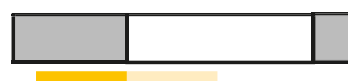

Sliding Door System for Very Heavy Doors : Topline Grant XHD



Salient Features

| | |
|-------------------|--|
| Maximum Wall Gap | 1500/1800 mm |
| Description | Sliding door system on Runner Profile |
| Number of Tracks | 1 Track |
| Door Action | Horizontal |
| Door Mount | Wall/Ceiling |
| Door Weight | 227 kg per door |
| Door Height | 3000 mm |
| Door Width | 1800 mm Max |
| Door Thickness | 25 mm Minimum |
| Door Combinations | Single Door, Bi Passing Door Bi Parting Door |
| Silent Systems | No |
| Special Features | Height Adjustment +/- 10 mm |

| Article No. | Description | Qty | Unit | PU | MRP |
|-----------------------------------|------------------------------------|-----|------|----|--------------|
| TopLine Grant XHD (12ft/3600 mm) | | | | | |
| 9 199 513 | XHD Runner Profile 3600 mm (12 ft) | 1 | Pc | 1 | 32140 |
| 9 191 126 | XHD Standard Installation Kit | 1 | Set | 1 | 15468 |
| TopLine Grant XHD (12 ft/3600 mm) | | | | | 47608 |

Quality Criteria

Conforms to ANSI/BHMA Standard Grade 1

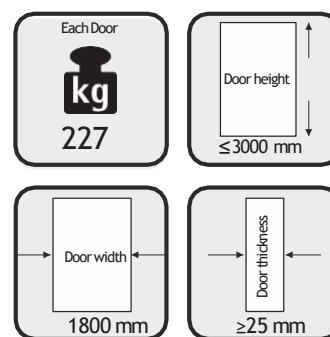

Single

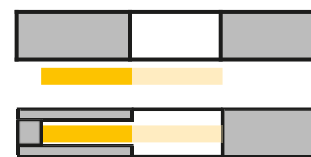

Bi-parting

Use additional set of Runner and Kit

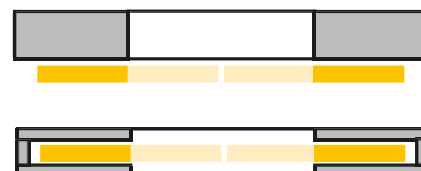

By-passing

Mounting two parallel tracks

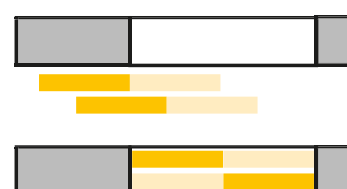

WingLine Grant 1260

Folding Partition Doors

1800

Superior mechanism for bi folding partition doors. :

WingLine Grant 1260



Salient Features

| | |
|-------------------|---------------------------------------|
| Maximum Wall Gap | 1800 mm |
| Description | Folding door system on Runner Profile |
| Number of Tracks | 1 Track |
| Door Action | Horizontal |
| Door Mount | Ceiling |
| Door Weight | 80 kg per door |
| Door Height | 1500 mm |
| Door Width | 900 mm Max |
| Door Thickness | 25 mm Minimum |
| Door Combinations | BiFold Doors |
| Silent Systems | No |
| Special Features | Height Adjustment +/- 12 mm |

| Article No. | Description | Qty | Unit | PU | MRP |
|--|--------------------------------------|-----|------|----|--------------|
| Topline Grant 1260 1 Door Set (10 ft, 3000 mm) | | | | | |
| 0 050 125 | Runner Profile 3000 mm (10 ft) | 1 | Pc | 4 | 4321 |
| 0 050 146 | Guide Profile 3000 mm (10 ft) | 1 | Pc | 4 | 2298 |
| 1 133 284 | Standard Installation for 1 set door | 1 | Set | 1 | 10376 |
| 0 050 141 | Guide Rollers | 1 | Pc | 1 | 859 |
| TopLine Grant 1260 1 Door Set (10ft; 3000 mm) | | | | | 17854 |
| Topline Grant 1260 1 Door Set (10 ft, 3000 mm) | | | | | |
| 0 050 126 | Runner Profile 3600 mm (12 ft) | 1 | Pc | 4 | 6324 |
| 0 050 147 | Guide Profile 3600 mm (12 ft) | 1 | Pc | 4 | 2461 |
| 1 133 284 | Standard Installation for 1 set door | 1 | Set | 1 | 10376 |
| 0 050 141 | Guide Rollers | 1 | Pc | 1 | 859 |
| TopLine Grant 1260 1 Door Set (12ft; 3600 mm) | | | | | 20020 |

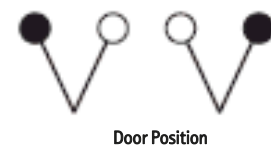
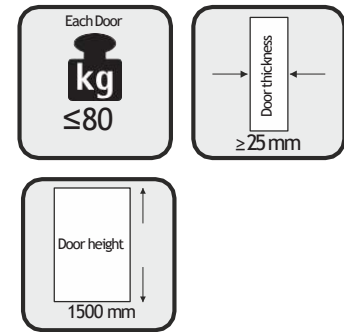

Centre Folding Hinges for Doors to be ordered separately

Quality Criteria

Conforms to ANSI/BHMA Standard Grade 1

Registered & Head Office:**Hettich India Private Limited**

302, Duro-lite House,
Opp. SAB TV, New Link Road,
Andheri (West), Mumbai - 400 053
Phone: +91 22 2674 3289/3356/4089
Fax: +91 22 2674 3267

Delhi Office:**Hettich India Private Limited**

A-26/4, 1st floor,
Mohan Co-operative Industrial Estate,
New Delhi - 110 044
Phone: +91 11 4889 4000, 4889 4005
Fax: +91 11 4889 4044

Application Centres:**New Delhi:**

61, Panchkuian Road,
New Delhi - 110001
Ph.No. :+91 11 2358 0713,
+91 11 2358 4603

Kolkata:

2nd Floor, Unit Number 2A,
Tirumala 22,
East Topsia Road,
Kolkata - 700046
Ph.No. :+91 98310 12054

Bangalore:

Adventz Center, Ground Floor 28,
Cubbon Road, Shivaji Nagar, Bangalore
- 560 001
Ph.No. :+91 80 4530 0400,
+91 80 4530 0401

Indore:

Office No.106 and 107-A,
"Brilliant Titanium",
Plot No.9, Scheme No.78, Part-II,
Indore - 452 010
Ph.No. : +91 96 9168 4480

Training Center Address:

Hettich Poddar Wood Work Institute
Plot No.2, 1st Floor, DLF Industrial Estate-1 Near
NHPC Metro Station,
Faridabad- Haryana
Ph: +91 129 4203888
Email: info@hpwwi.com

Mumbai:

202, Duro-lite House, Opp.SAB TV, New
Link Road, Andheri (West), Mumbai -
400053
Ph.No. :+91 22 2639 9707

Hyderabad:

"Sai Krishna "797 -
A, 2nd Floor,
Road No. 36, Jubilee Hills,
Hyderabad - 500 034
Ph.No. :+91 40 2355 8994

Kochi:

41/2062D, 2nd Floor
Palarivattom signal junction,
NH 47 By-pass, Kochi -
682 028
Ph.No. : +91 48 4402 8242

Chennai:

"Heavitree", Ground Floor, 47, Spur
Tank Road, Chetpet, Chennai -
600 031
Ph.No. :+91 44 4263 7227

Ahmedabad:

1st Floor, Unit No. 102,
Safal Pegasus,
Anand Nagar,
Ahmedabad - 380 015,
Ph.No. :+91 79 4032 2824

Chandigarh:

2nd Floor, Aspire Tower,
Plot no.55, Industrial
& Business park, Phase 1,
Chandigarh - 160 002
Ph.No. : +91 172 5012 347

Enquiry & Customer Services Toll

Free :1800 209 2096 (office hours) Email:
sales_enquiry@in.hettich.com
customer_services@in.hettich.com
www.hettich.com

Technik für Möbel

The Hettich logo consists of a stylized graphic of four parallel diagonal lines above the word "Hettich" in a bold, sans-serif font.